

MEET YOUR

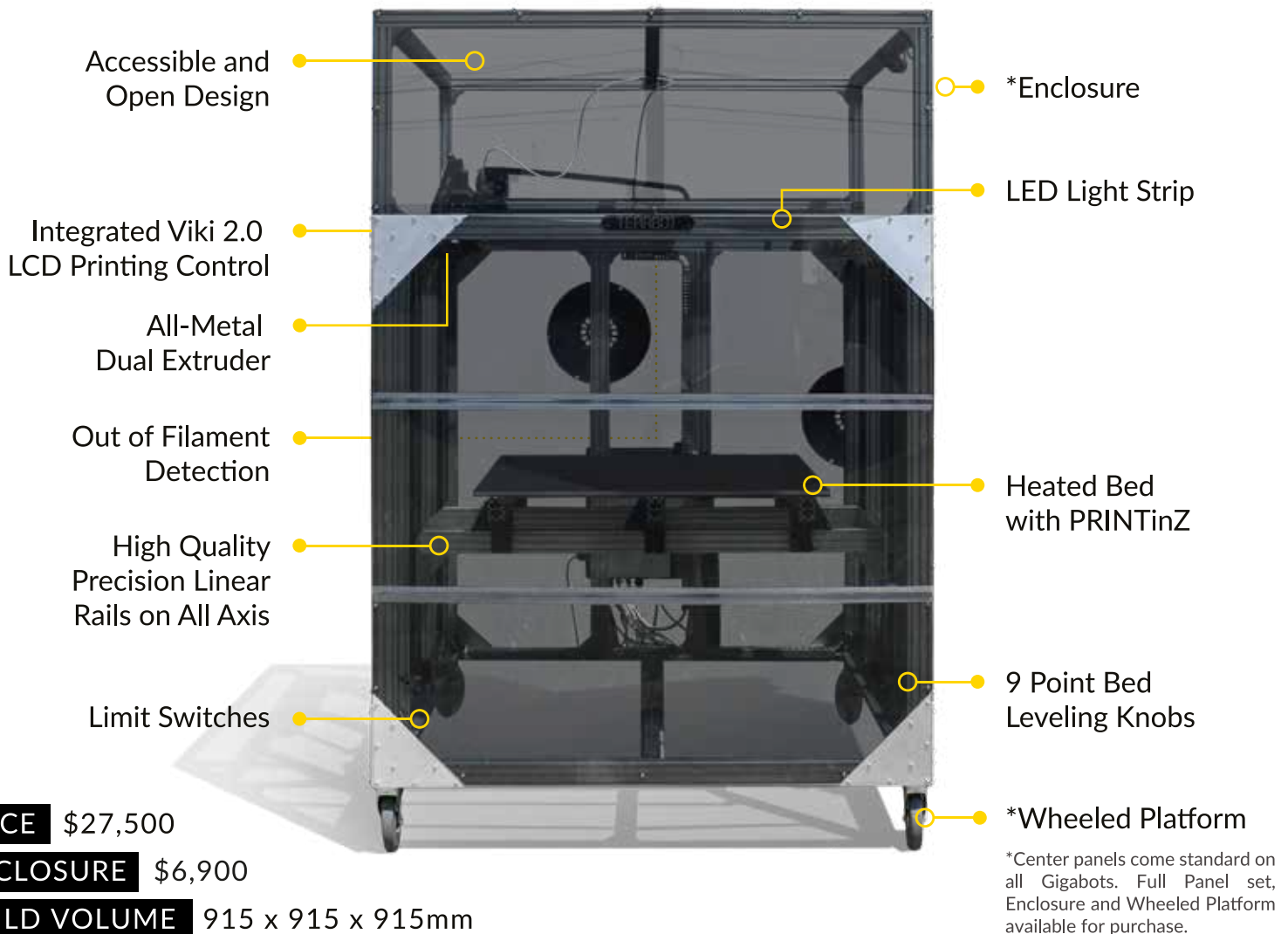

TERABOT[®]

Affordable | Quality | Industrial | Large-Scale | Hand-Crafted



3D PRINTING AT THE Human Scale

Industrial 3D printing is now affordable. The massive print volume starts at 30X larger than desktop 3D printers, at a fraction of the cost of industrial systems.

FOR HIGH-STRENGTH Materials

Print with thermoplastics that melt below 320°C, Terabot's all-metal hot end opens the door to a wider variety of 3D printing materials, including both high-strength and heat-resistant plastic filaments.

MODULAR, LIFETIME Construction

Free from the constraints of product versioning, the Terabot platform enables user upgrades and customization. No machine will fall behind with new features available as add-on packages.

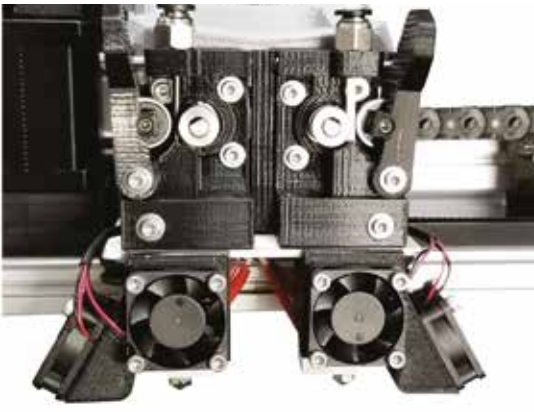

DESIGN & RESEARCH FOCUSED ON YOUR NEEDS

Full Service Solutions

re:3D is ready to assist you with your industrial large-scale 3D printing needs.

Our team is experienced in fabricating built-to-spec modified hardware for specialized print requests and available to support material selection, design, contract printing, education and consulting needs.

All Terabots are covered under our factory warranty for six months, including damage due to normal wear and tear, user error or faulty parts. Extended warranty options and maintenance plans are available up to three years.

Printing Specs



Compatible with Hardened Steel & Mondo Hot Ends

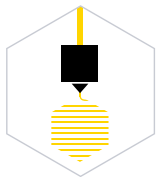

Supports Thermoplastics Melting Below 320°C



100-600 Micron Layer Resolution



60-100 mm/sec Printing Speed

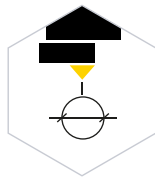

0.4 or 0.8 mm Nozzle Diameter

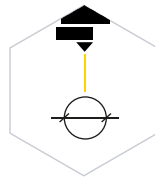

2.85 mm Filament Diameter



Robust Aluminum Cartesian Frame



Cast Aluminum Blanchard Ground Flat Build Plate

Mechanical

Software

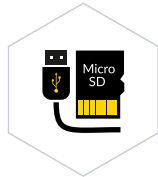

Micro SD or USB File Transfer Method

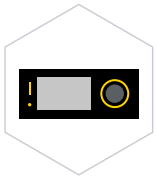

VIKI 2.0 LCD Bot Control



Compatible with Mac, Windows and Linux OS

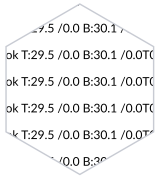

G-code (.gco) Upload File Type



Recommended Software: Simplify3D



110/220 V (975-2200 Watts) 50/60HZ



180-320°C Extruder Temperature



60-115°C Build Surface Temperature

Electrical

Other Solutions



DIY PARTS KIT
GIGABOT®

590 x 600 x 600mm

GIGABOT® \$8,950

Enclosure \$2,950



FULLY ASSEMBLED
GIGABOT®

590 x 600 x 600mm

GIGABOT® \$11,950

Enclosure \$2,950



FULLY ASSEMBLED
GIGABOT® XL

590 x 760 x 600mm

GIGABOT® XL \$13,950

Enclosure XL \$3,250



FULLY ASSEMBLED
GIGABOT® XLT

590 x 760 x 900mm

GIGABOT® XLT \$16,995

Enclosure XLT \$3,500



FULLY ASSEMBLED
Custom Solutions

Our team of experts are available to quickly fabricate a Gigabot that fulfills your unique size and material requirements.