

MEET YOUR



GIGABOT[®] X

Affordable | Quality | Industrial | Large-Scale | Hand-Crafted

Pellets & Flake



Cost Saving

Printing with a larger nozzle while using pellets or flake is 5-10x cheaper than traditional filament.

Faster

The Gigabot X's larger 0.8, 1.75 or 2.85mm nozzle reduces printing time, up to 17x faster than Fused Filament Fabrication printers.

Versatile

Capable of printing with 1/8" plastic granules melting below 270°C, reducing dependence on printing with filament while supporting plastic granule mixing.

Price starting at \$16,950

Build Volume: 580 x 600 x 470 mm

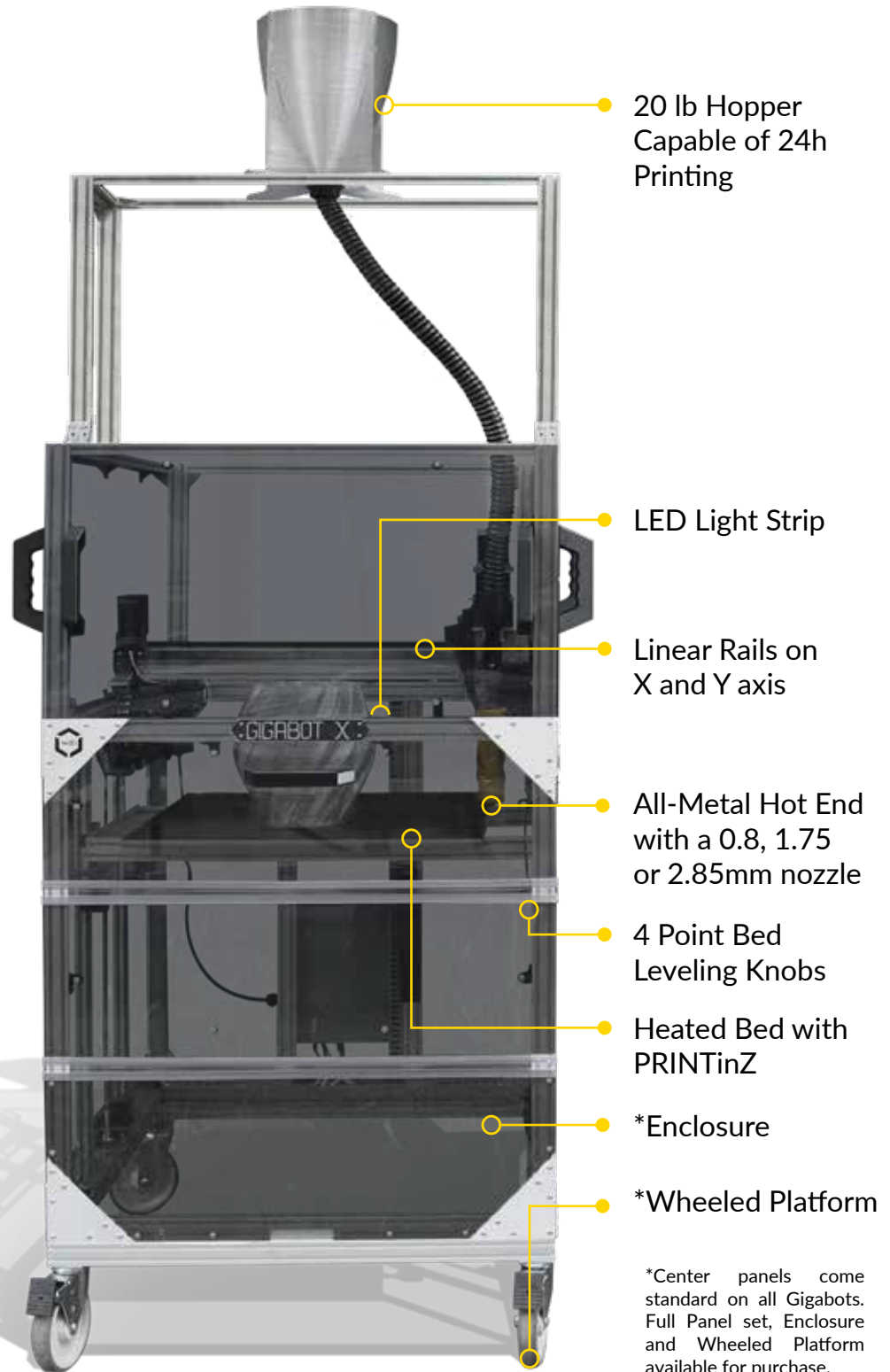

DESIGN & RESEARCH FOCUSED ON YOUR NEEDS

Full Service Solutions



re:3D is ready to assist you with your industrial large-scale 3D printing needs.

Our team is experienced in fabricating built-to-spec modified hardware for specialized print requests and available to support material selection, design, contract printing, education and consulting needs.

Simply email sales@re3d.org for a quote and to speak with an expert who can advise you on our services to take you from idea to print.

Printing Specs



All-Metal Hot End



Supports 1/8 inch plastic granules



450-2,250 Micron Layer Resolution



30 mm/sec Printing Speed

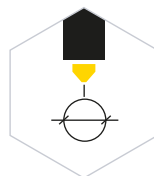

0.8, 1.75 or 2.85mm Nozzle Diameter



1 mm Standard Layer Height



Robust Aluminum Cartesian Frame



Cast Aluminum Blanchard Ground Flat Build Plate

Mechanical

Software

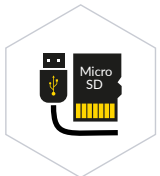

Micro SD or USB File Transfer Method

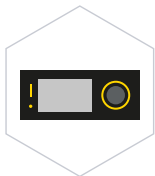

VIKI 2.0 LCD Bot Control



Compatible with Mac, Windows and Linux OS

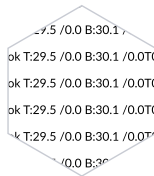

G-code (.gcode) Upload File Type



Recommended Software: Simplify3D



110/220 V (975-2200 Watts) 50/60HZ



120-270°C Extruder Temperature



20-115°C Build Surface Temperature

Electrical

Gigabot X Solutions

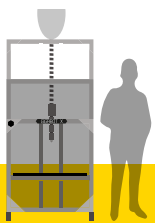

FULLY ASSEMBLED
GIGABOT[®] X

580 x 600 x 470mm

GIGABOT[®] \$16,950

Enclosure \$2,950

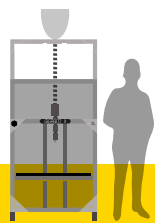

FULLY ASSEMBLED
GIGABOT[®] X XL

580 x 760 x 470mm

GIGABOT[®] XL \$18,950

Enclosure XL \$3,250

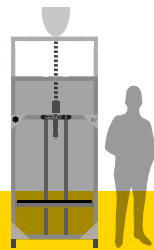

FULLY ASSEMBLED
GIGABOT[®] X XLT

580 x 760 x 770mm

GIGABOT[®] XLT \$21,995

Enclosure XLT \$3,500

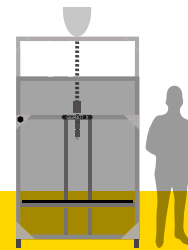

FULLY ASSEMBLED
TERABOT[®] X

915 x 915 x 785mm

TERABOT[®] \$32,500

Enclosure \$6,900

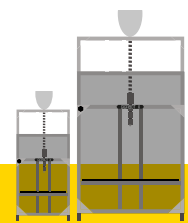

FULLY ASSEMBLED
Custom Solutions

Our team of experts are available to quickly fabricate a Gigabot that fulfills your unique size and material requirements.